

NANLITE

FC-300B *LED Bi-color Spot Light*

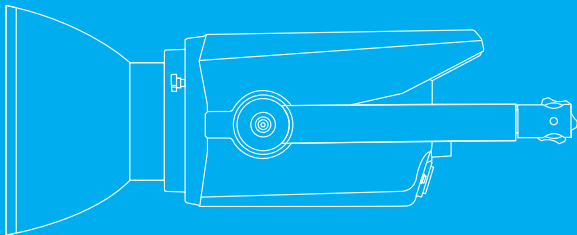

USER MANUAL

Introduction

Thank you for purchasing Nanlite product--FC-300B!

FC-300B is a LED bi-color spot light designed for content creators and photographers. With stylish and compact fixture body, FC-300B has remarkable performance: 350W rated power, 2700K-6500K CCT adjustment, 4 fan modes, 12 built-in effects, and combined with different control options including on-board, remote control, Nanlink App and DMX/RDM. Moreover, equipped with Bowens mount and umbrella hole, FC-300B is compatible with numerous modifiers to create various lighting effects.

Notice

1. Please do not look directly at the emitter when the fixture is on.
2. Please keep for 10s after settings before turn off the fixture.
3. Please do not place any object on the fixture or allow liquid to flow inside the fixture.
4. Please do not place the fixture near any flammable or volatile substances like alcohol or gasoline.
5. Please do not use strong detergent for cleaning. Please wipe off the dirt by using a cloth with neutral cleanser when cleaning the fixture.
6. Please set up the fixture in a dry and well-ventilated place. Please do not use it in any humid, dusty or overheated environment. Meanwhile, please also check whether the fan and vent are unimpeded.
7. Please do not disassemble the fixture to repair at will. Qualified professionals should conduct maintenance under the condition of strictly following the operating procedures described in this manual.
8. Please do not cover the vents when using, to avoid affecting heat dissipation, and resulting in damage. Please pay attention to anti-scald when using the fixture for a long time, since the surface temperature of fixture will be high.

FC-300B LED Bi-color Spot Light

■ Product Diagram

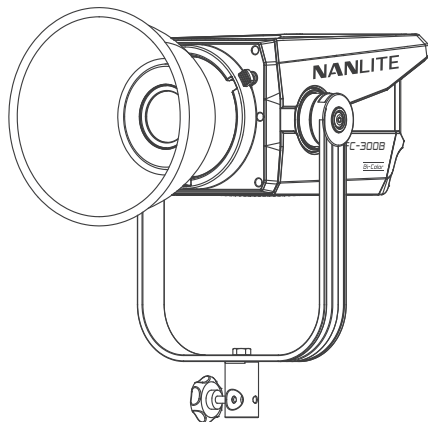

■ Technical Data

Rated Power: 350W

Input: DC 48V/6.6A Max

AC 100-240V 50/60Hz

Color Temperature: 2700K-6500K

CRI: Average 96

TLCI: Average 98

Product Details

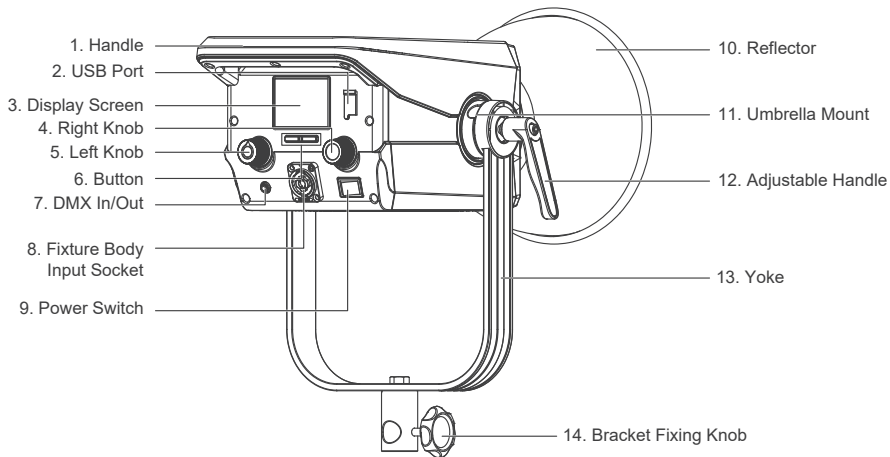

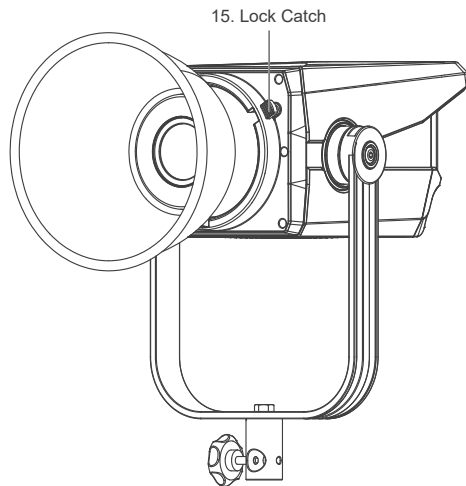



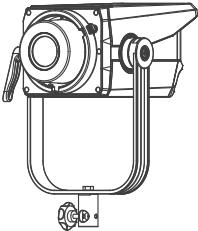

Detailed Description

1. Handle: Offer convenient grip for adjusting direction of illumination.
2. USB Port: For updating firmware.
3. Display Screen: For displaying datas.
4. Right Knob: For selecting various options and adjusting the color temperature in the CCT mode.
5. Left Knob: For adjusting the DIM and adjusting parameters.
6. Button: MODE button for switching between CCT mode and EFFECT mode, MENU button for switching to the menu.
7. DMX In/Out: Connect to DMX adapter cable for DMX signal input and output.
(Note: DMX adapter cable is sold separately).
8. Fixture Body Input Socket: To connect a DC cable for connecting between fixture body and power supply.
9. Power Switch: To turn on/off the fixture.
10. Reflector: For concentrating light to improve the central illumination.
11. Umbrella Mount: For installing an umbrella.
12. Adjustable Handle: Tighten or release the tilt movement of the fixture on the yoke.
13. Yoke: For mounting the fixture on the light stand and adjusting the direction of illumination.
14. Bracket Fixing Knob: For locking the light fixture on the stand, and for pan adjustment of fixture.
15. Lock Catch: To lock or release the reflector or other accessories.

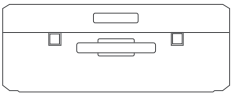
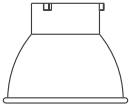
Includes

<p>FC-300B×1</p>	<p>Power Supply × 1</p>	<p>AC Power Cable × 1</p>
		
<p>Carry Case × 1</p>	<p>Reflector × 1</p>	<p>User Manual × 1</p>
		

Usage

1. Installation and Detachment of Reflector

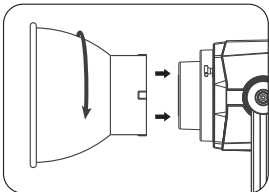

When installing the reflector, align the reflector to the fixture's Bowens mount, rotate the reflector in the direction shown on the fixture until it clicks into place.

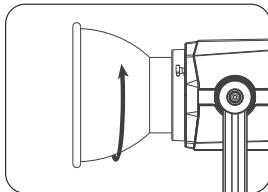

When removing the reflector, push and hold the lock catch and rotate the reflector until it is free to be removed from the fixture.

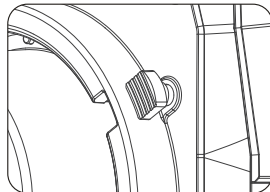

Press the lock catch to remove the reflector.

2. Installation of Umbrella

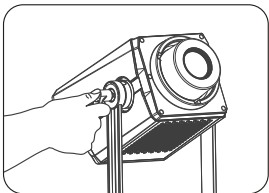

Loosen the adjustable handle.

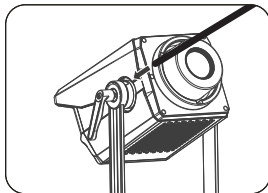

Insert the umbrella into the umbrella mount.

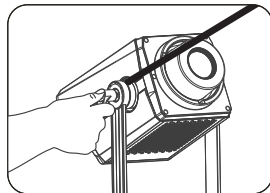

Tighten the adjustable handle to lock the umbrella.

Remote Control

· FC-300B supports DMX, RDM and 2.4G remote control, and it also has built-in Bluetooth module.

▲ The address needs to be set before operating the remote control via DMX, RDM and 2.4G.

1. ADDRESS/DMX Setting, including ADDRESS, DMX MODE, DMX REDUCED CHANNELS, DMX DIMMING CURVE and DMX SMOOTHING.

1.1 ADDRESS Setting

Press the MODE button to enter the menu.

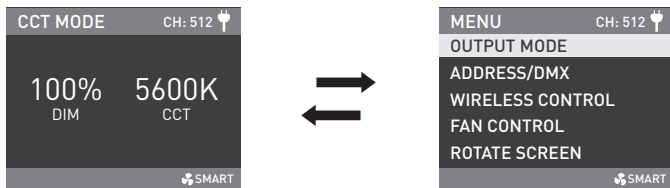

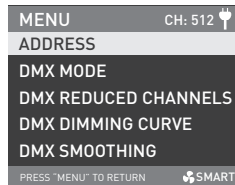
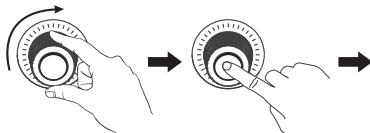
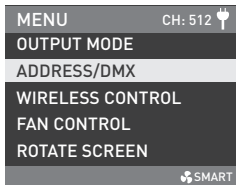

Rotate the right knob to ADDRESS/DMX and press the right knob to enter the secondary menu.

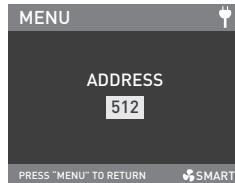
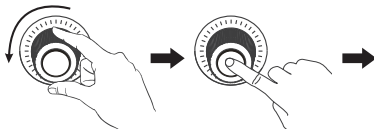
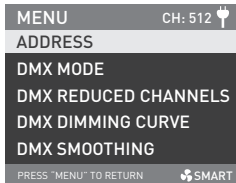

Rotate the right knob to ADDRESS, and press the right knob to enter the tertiary menu.

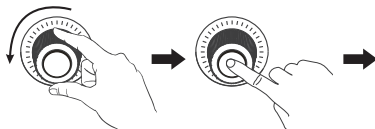
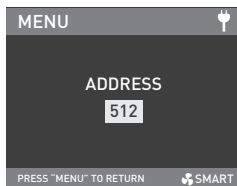

Rotate the right knob to select needed address and press the right knob to set.

1.2 DMX MODE

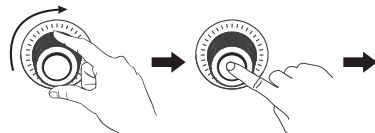
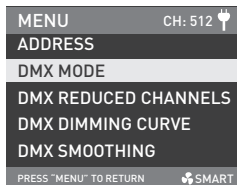

Rotate the right knob to DMX MODE, and press the right knob to enter the tertiary menu.

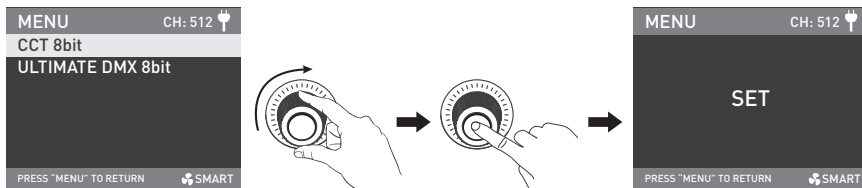

Rotate the "right knob" to select CCT 8bit or ULTIMATE DMX 8bit, and press the right knob to set.

1.3 DMX REDUCED CHANNELS

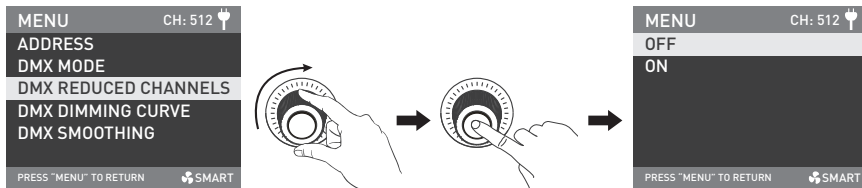

Rotate the right knob to DMX REDUCED CHANNELS, and press the right knob to enter the tertiary menu.

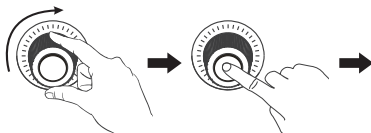
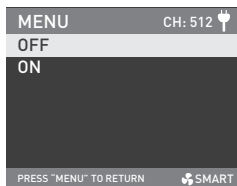

Rotate the right knob to select ON or OFF, and press the right knob to set.

1.4 DMX DIMMING CURVE

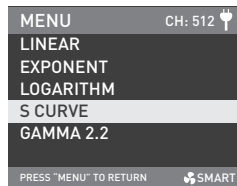
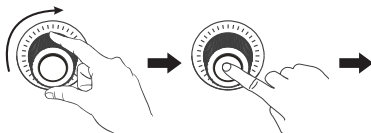
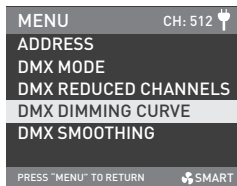

Rotate the right knob to DMX DIMMING CURVE, and press the right knob to enter the tertiary menu.

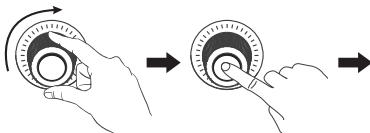
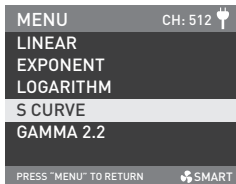

Rotate the right knob to select LINEAR, EXPONENT, LOGARITHM, S CURVE or GAMMA 2.2, and press the right knob to set.

1.5 DMX SMOOTHING

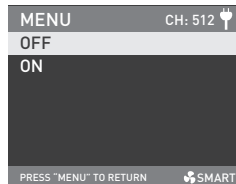
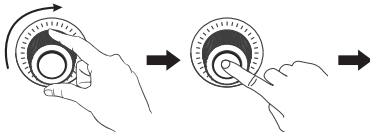
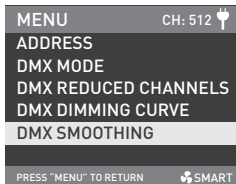

Rotate the right knob to DMX SMOOTHING, and press the right knob to enter the tertiary menu.

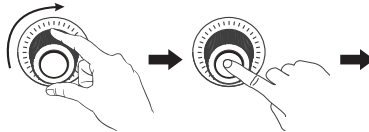
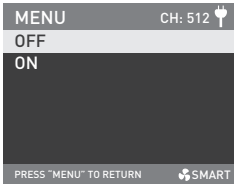

Rotate the right knob to select ON or OFF, and press the right knob to set.

2 DMX Control

2.1 Connect the fixture to the DMX/RDM consoles via DMX cable as shown below:



- 5-pin shielded cable with a diameter not less than 0.3mm must be used for connection between light fixture and DMX/RDM console, or between light fixture and light fixture. XLR plug/socket and the cable should be connected as shown above.
- Pin1, Pin2, Pin3 for connecting DMX signal. Pin4, Pin5 have no connection.
- ▲NOTE: When connecting DMX, make sure the internal pin is not in contact with the inner case, and pins should not be in contact with each other. The fixture can match the DMX512 (1990) control signal.
- 5-pin and 3-pin XLR plug/socket conversion
- The fixture comes with 5-pin XLR plug/socket. If a 3-pin XLR plug is used, please follow the instruction below.

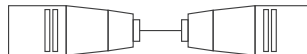
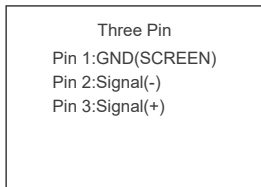
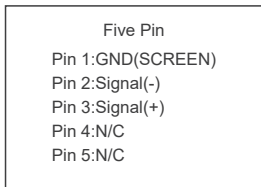

2.2 DMX Terminator

In DMX control mode, the DMX output of the last light fixture should be connected with a DMX terminator (not included). The terminator is connected with a 120Ω(OHM) resistor across Pin 2 and Pin 3 (As shown below). This prevents interference caused by DMX signals in the transmitting process.

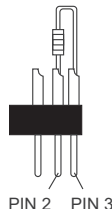
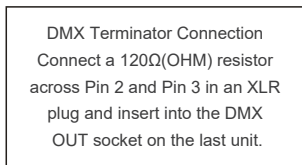
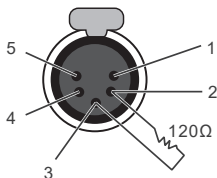

2.3 Address Setting of the Light Fixture.

2.4 Refer to the DMX reference guide and control the fixture via DMX/RDM console.

(For detailed operation please refer to the DMX/RDM console operation manual.)

2.5 Download the latest technical data from <https://www.nanlite.com/index#/en>.

3 RDM Control

3.1 Connect the light fixture to the console with RDM function by using a connection cable, the connecting method is the same as that of DMX/RDM console.

3.2 Control the fixture via a console with RDM function. (For specific operation methods, please refer to the RDM console operation manual.)

Note: The UID format of the fixture is as follow:

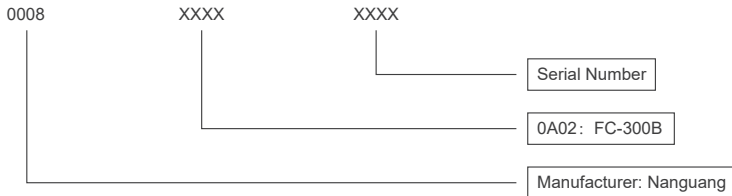

4. WIRELESS CONTROL

4.1 FC-300B has built-in Bluetooth function for connection via Bluetooth.

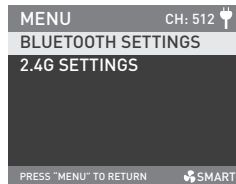
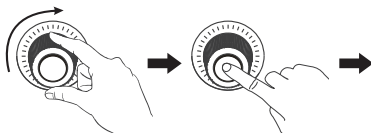
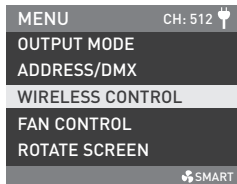

Rotate the right knob to WIRELESS CONTROL, and press the right knob to enter the secondary menu.

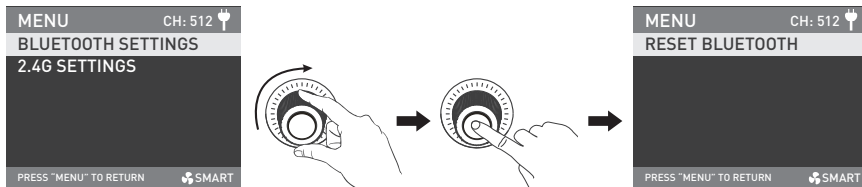

Rotate the right knob to BLUETOOTH SETTINGS, and press the right knob to enter the tertiary menu.

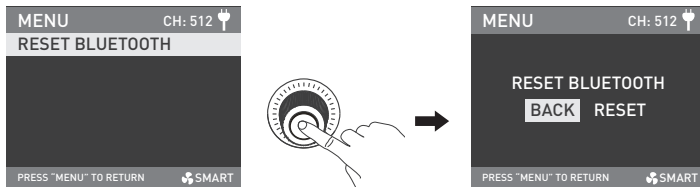

Press the right knob enter the interface of RESET.

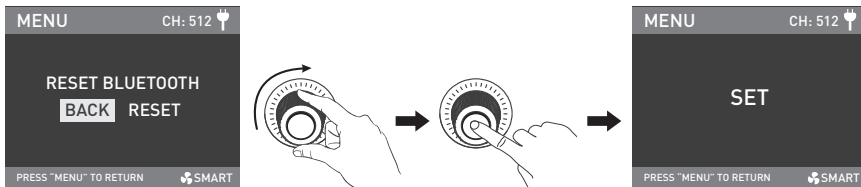

Rotate the right knob to RESET, and press the right knob to set.

4.2 2.4G Setting

FC-300B can be remotely controlled by 2.4G remote controller and by Nanlink App via the WS-TB-1 transmitter box.

Note: ① 2.4G remote controller and WS-TB-1 transmitter box are sold separately.

② FC-300B supports the 2.4G wireless protocol V1.0 and V2.0. The fixture should be set in V2.0 while using WS-RC-C2 remote controller, set in V1.0 while using other remote controllers.

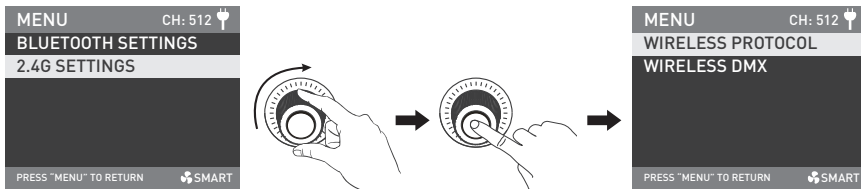

Rotate the right knob to 2.4G SETTINGS, and press the right knob to enter the tertiary menu.

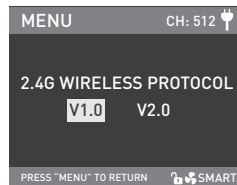
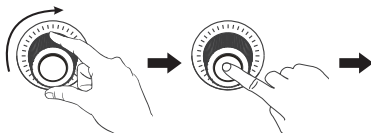
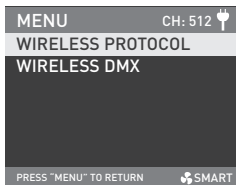

Rotate the right knob to WIRELESS PROTOCOL, and press the right knob to enter the next menu.

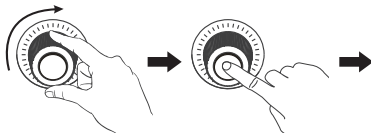
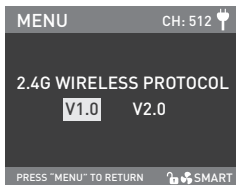

Rotate the right knob to select V1.0 or V2.0, and press the right knob to set.

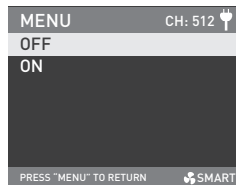
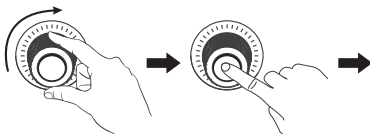
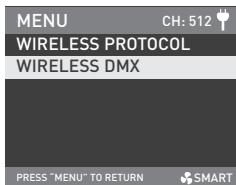

Rotate the right knob to WIRELESS DMX, and press the right knob to enter the next menu.

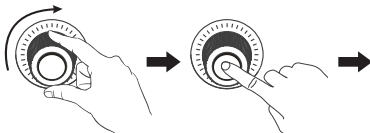
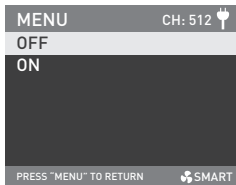

Rotate the right knob to select ON or OFF, and press the right knob to set.

When WIRELESS DMX is on, the WIRELESS DMX UNIVERSE can be adjusted.

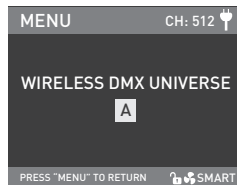
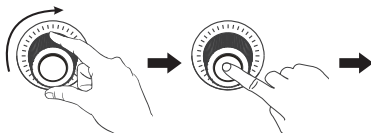
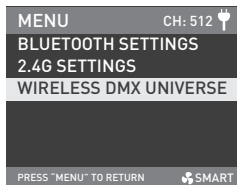

Rotate the right knob to WIRELESS DMX UNIVERSE, and press the right knob to enter the next menu.

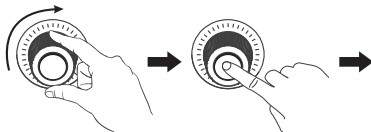
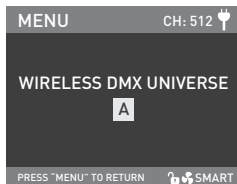

Rotate the right knob to select the needed universe, and press the right knob to set.
Remote control or transmitter box can't be used when wireless DMX is on.

Operating Instructions

1. Make sure the fixture is off, connect the fixture with the power supply, and connect the power cable, turn on the power switch, the screen will display "NANLITE".

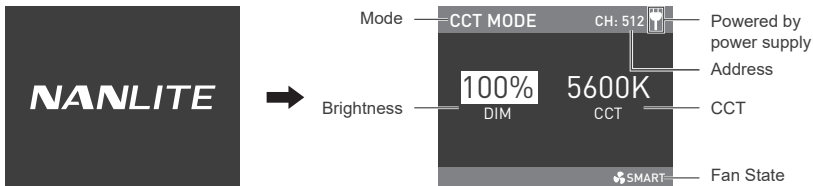

2. MODE Button: Press the MODE button to switch between CCT mode and EFFECT mode.

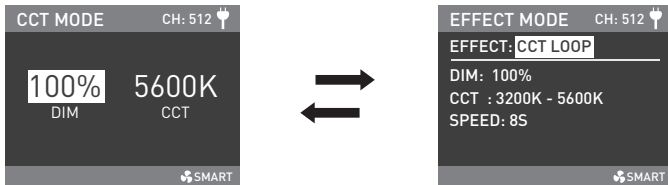

2.1 CCT Mode

Press the MODE button to switch to CCT mode.

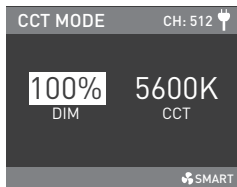

- ① DIM Setting, Rotate the left knob clockwise to increase the brightness, rotate anticlockwise to decrease, the percentage will be shown on the screen, DIM range: 0% -- 100%.

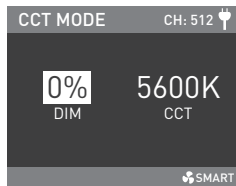
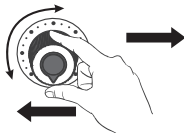
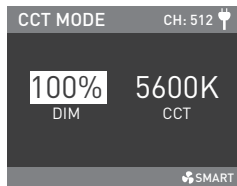

Note: In other modes, the DIM range is the same as that in CCT MODE. In any mode, press the left knob to turn off the light, and the DIM percentage on the screen will be 0%. Press again to restore the fixture to its previous state. Press continuously to switch the light between on and off.

② CCT Setting, Rotate the right knob clockwise to increase the color temperature, rotate anticlockwise to decrease, the CCT value will be shown on the screen, CCT range: 2700K -- 6500K.

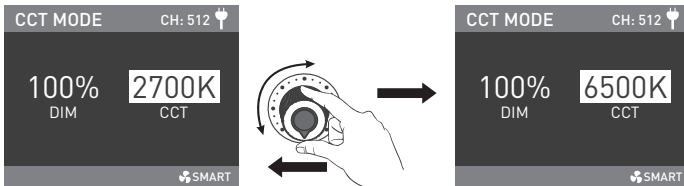

Note: In other modes, the CCT range is the same as that in CCT MODE. Presss the right knob to promptly toggle among: 2700K, 3200K, 4300K, 5600K and 6500K, which can be toggled in a loop.

2.2 EFFECT Mode

FC-300B has built-in effects including CCT LOOP, INT LOOP, FLASH, PULSE, STORM AUTO, STORM MANUAL, TV, PAPARAZZI, CANDLE/FIRE, BAD BULB, FIREWORK, EXPLOSION AUTO, EXPLOSION MANUAL and WELDING.

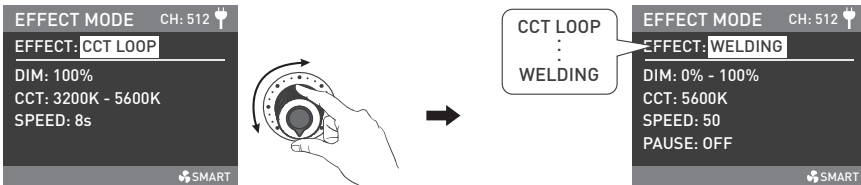

Rotate the left knob to select the needed effect, they can be selected in a loop.

① CCT LOOP

Rotate the right knob to select DIM, CCT or SPEED (range: 2s-30s), and rotate the left knob to set the corresponding parameters.

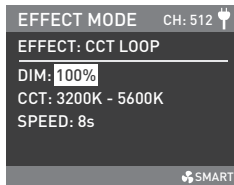
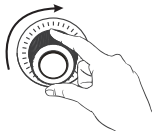
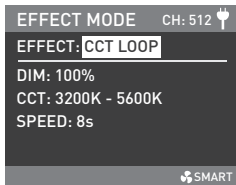

Rotate the right knob to select DIM, CCT or SPEED.

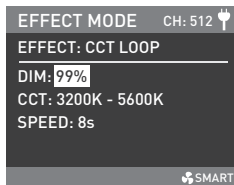
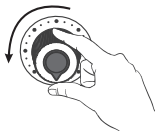
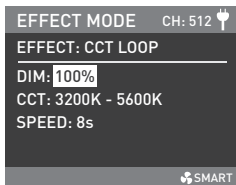

Rotate the left knob to set the corresponding parameters.

② INT LOOP

Rotate the right knob to select DIM, CCT or SPEED (range: 2s-30s), and rotate the left knob to set the corresponding parameters.

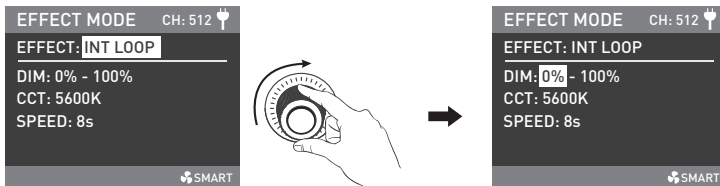

Rotate the right knob to select DIM, CCT or SPEED.

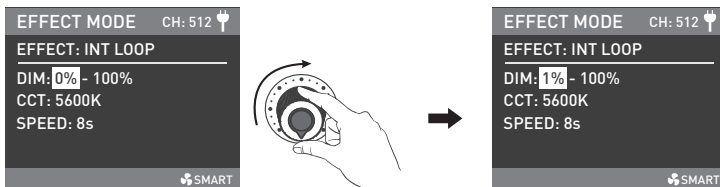

Rotate the left knob to set the corresponding parameters.

③ FLASH

Rotate the right knob to select DIM, CCT, G/M, INTERVALS (range: 0.1s-10.0s) or FLASH RATIO (range from: 0% -100%), and rotate the left knob to set the corresponding parameters.

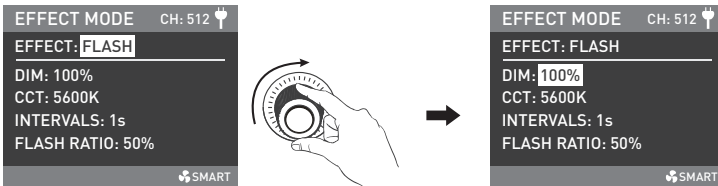

Rotate the right knob to select DIM, CCT, G/M, INTERVALS or FLASH RATIO.

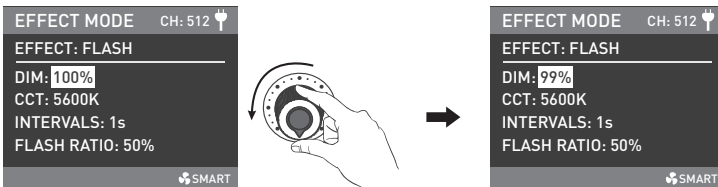

Rotate the left knob to set the corresponding parameters.

④ PULSE

Rotate the right knob to select DIM, CCT or PULSES/MIN (range: 1-240), and rotate the left knob to set the corresponding parameters.

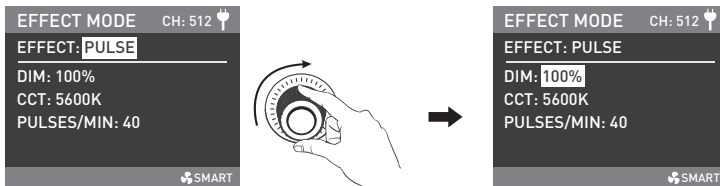

Rotate the right knob to select DIM, CCT or PULSES/MIN.

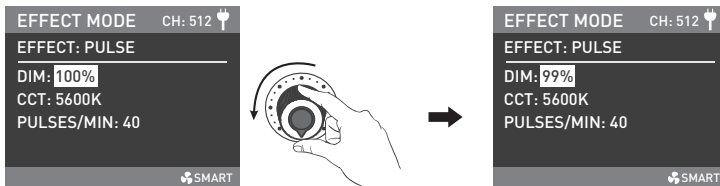

Rotate the left knob to set the corresponding parameters.

⑤ STORM AUTO

Rotate the right knob to select DIM, CCT or INTERVAL RANGE (range: 1s-60s) , and rotate the left knob to set the corresponding parameters.

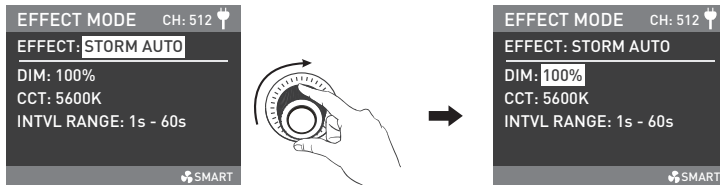

Rotate the right knob to select DIM, CCT or INTERVAL RANGE.

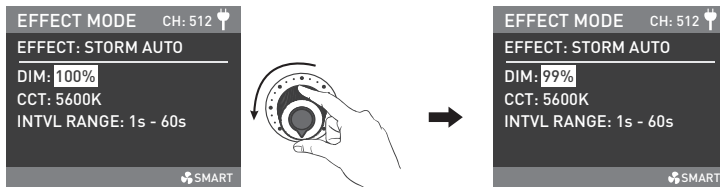

Rotate the left knob to set the corresponding parameters.

⑥ STORM MANUAL

Rotate the right knob to select DIM or CCT, and rotate the left knob to set the corresponding parameters, press the right knob to trigger the storm effect.

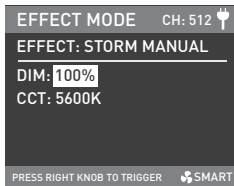
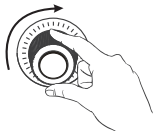
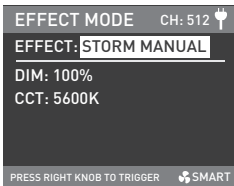

Rotate the right knob to select DIM or CCT.

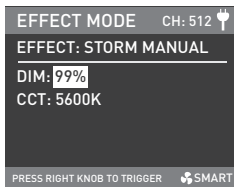
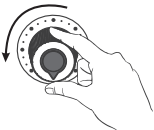
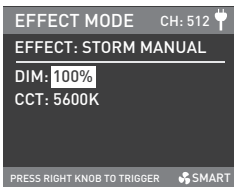

Rotate the left knob to set the corresponding parameters.

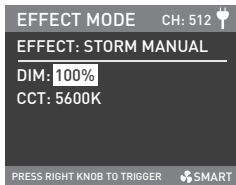

Press the right knob to trigger the storm effect.

⑦ TV

Rotate the right knob to select DIM, CCT, CCT SHITF (range: 0K-3000K) or SPEED (range: 1-100), and rotate the left knob to set the corresponding parameters.

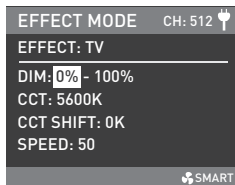
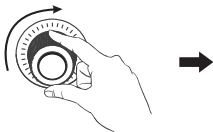
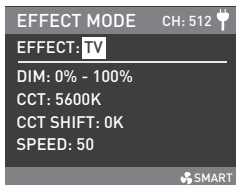

Rotate the right knob to select DIM, CCT, CCT SHITF or SPEED.

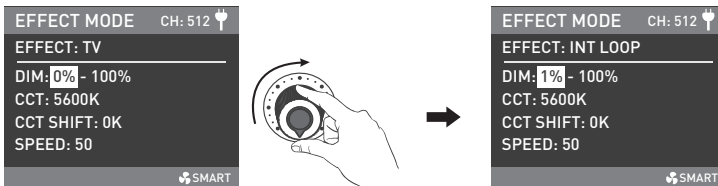

Rotate the left knob to set the corresponding parameters.

⑧ PAPARAZZI

Rotate the right knob to select DIM, CCT or SPEED (range:1-100), and rotate the left knob to set the corresponding parameters.

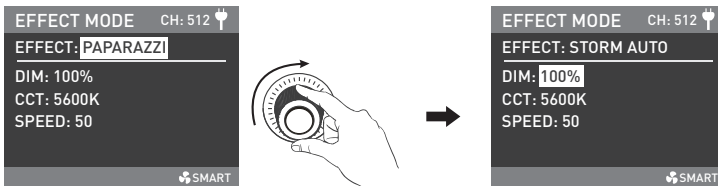

Rotate the right knob to select DIM, CCT or SPEED.

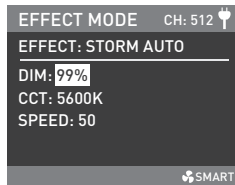
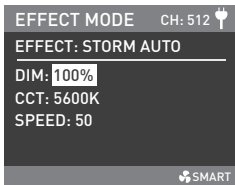

Rotate the left knob to set the corresponding parameters.

⑨ CANDLE/FIRE

Rotate the right knob to select DIM, CCT, CCT SHITF (range: 0K-3000K) or SPEED (range: 1-100), and rotate the left knob to set the corresponding parameters.

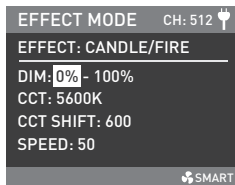
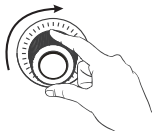
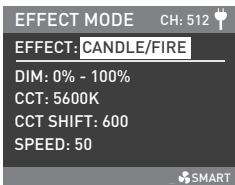

Rotate the right knob to select DIM, CCT, CCT SHITF or SPEED.

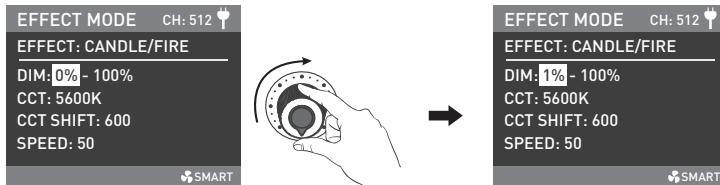

Rotate the left knob to set the corresponding parameters.

⑩ BAD BULB

Rotate the right knob to select DIM, CCT, INTENSITY (range: 1-100) or SPEED (range: 1-100), and rotate the left knob to set the corresponding parameters.

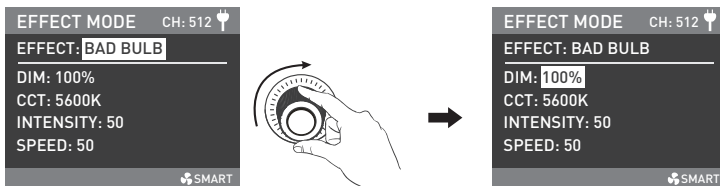

Rotate the right knob to select DIM, CCT, INTENSITY or SPEED.

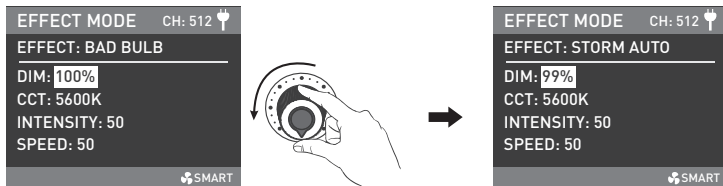

Rotate the left knob to set the corresponding parameters.

⑪ FIREWORK

Rotate the right knob to select DIM, CCT, G/M, SPEED (range: 1-100) or DECAY (range: 1-100), and rotate the left knob to set the corresponding parameters.

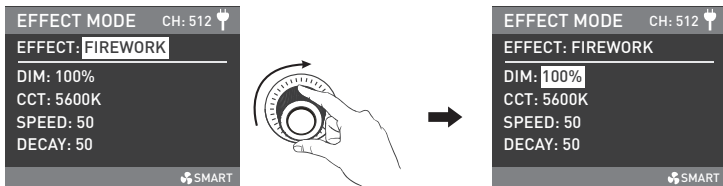

Rotate the right knob to select DIM, CCT, G/M, SPEED or DECAY.

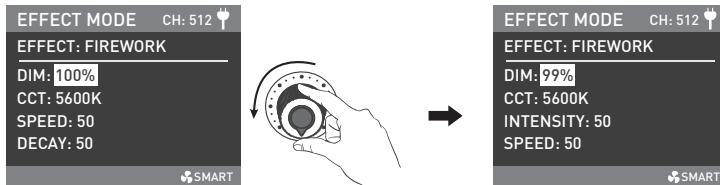

Rotate the left knob to set the corresponding parameters.

⑫ EXPLOSION AUTO

Rotate the right knob to select DIM, CCT, SPEED (range: 1-100) or DECAY (range: 1-100), and rotate the left knob to set the corresponding parameters.

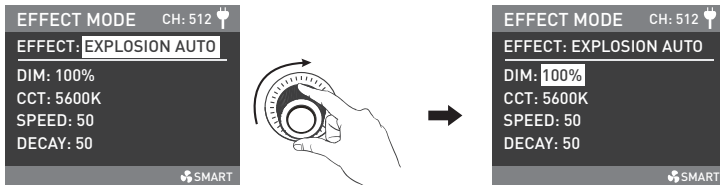

Rotate the right knob to select DIM, CCT, SPEED or DECAY.

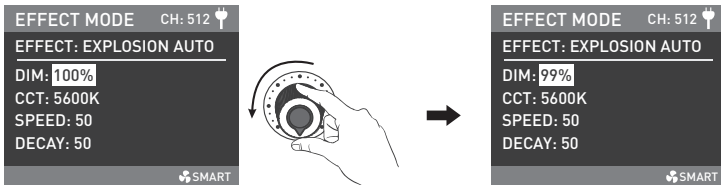

Rotate the left knob to set the corresponding parameters.

⑬ EXPLOSION MANUAL

Rotate the right knob to select DIM, CCT or DECAY (range 1-100), and rotate the left knob to set the corresponding parameters, press the right knob to trigger the explosion effect.

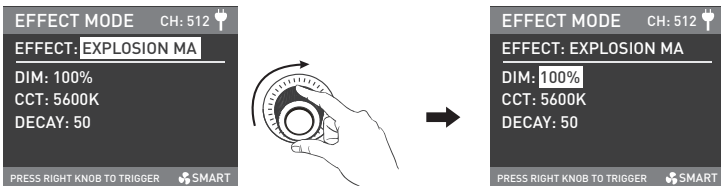

Rotate the right knob to select DIM, CCT or DECAY.

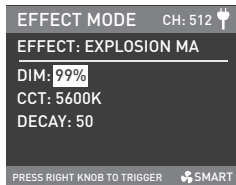
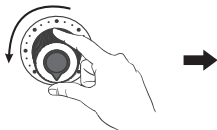
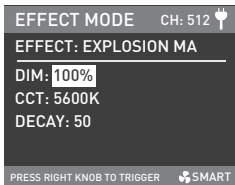

Rotate the left knob to set the corresponding parameters.

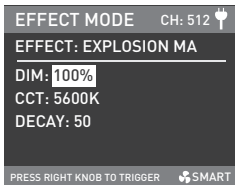

Press the right knob to trigger the explosion effect.

⑭ WELDING

Rotate the right knob to select DIM, CCT, SPEED (range: 1-100) or PAUSE, and rotate the left knob to set the corresponding parameters.

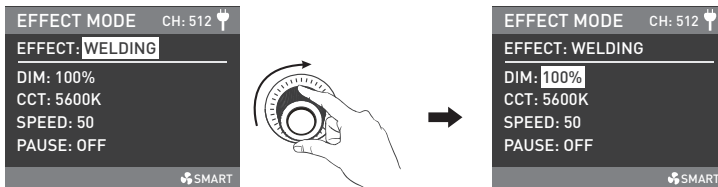

Rotate the right knob to select DIM, CCT, SPEED or PAUSE.

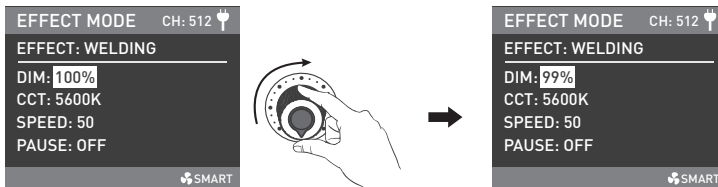

Rotate the left knob to set the corresponding parameters.

NOTE: The PAUSE can be set on/off. When the PAUSE is on, the welding effect will pause. Lighting effects and additional functionality will be probably updated with later firmware version. Detailed information is subject to the instruction of firmware function.

3. MENU Button: Press the MENU button to enter the interface of menu.

Rotate the right knob to select the options, press the right knob to enter the secondary menu, and rotate the right knob to select the corresponding parameters, then press the right knob to set. Press the MENU button to return to the previous menu.

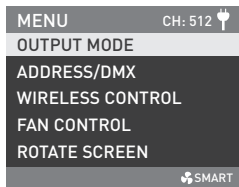

3.1 OUTPUT MODE

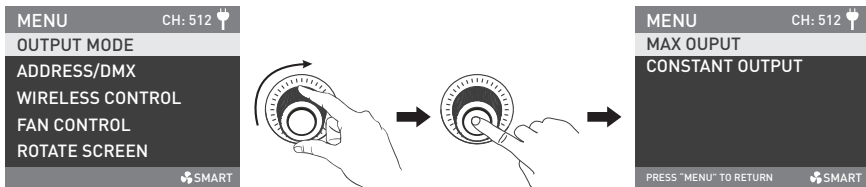

Rotate the right knob to **OUTPUT MODE**, and press the right knob to enter the secondary menu.

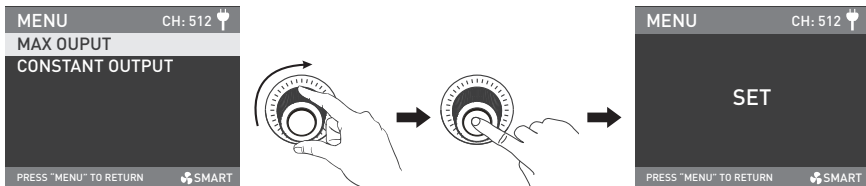

Rotate the right knob to select **MAX OUPUT** or **CONSTANT OUTPUT**, and press the right knob to set.

3.2 ADDRESS/DMX

For detailed operations please refer to P8.

3.3 WIRELESS CONTROL

For detailed operations please refer to P16.

3.4 FAN CONTROL

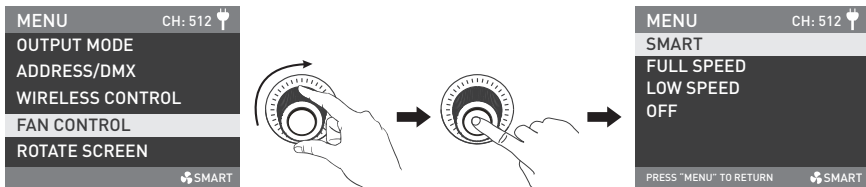

Rotate the right knob to FAN CONTROL, and press the right knob to enter the secondary menu.

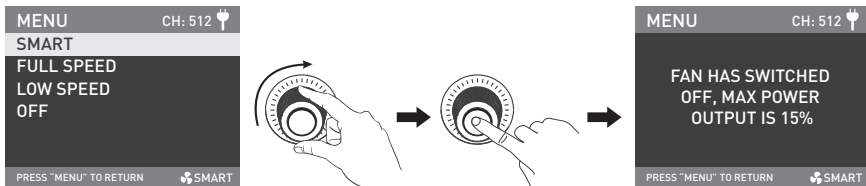

Rotate the right knob to select SMART, FULL SPEED, LOW SPEED or OFF, and press the right knob to set.

Note: When the fan is in off state, the fan will stop working, at this moment the maximum power output of the fixture is 15%.

When the fan is in LOW SPEED state, the maximum power output of the fixture is 50%.

When the fan is in SMART or FULL SPEED state, the maximum power output of the fixture is 100%.

3.5 ROTATE SCREEN

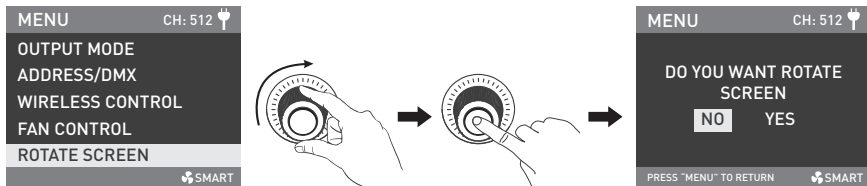

Rotate the right knob to ROTATE SCREEN, and press the right knob to enter the secondary menu.

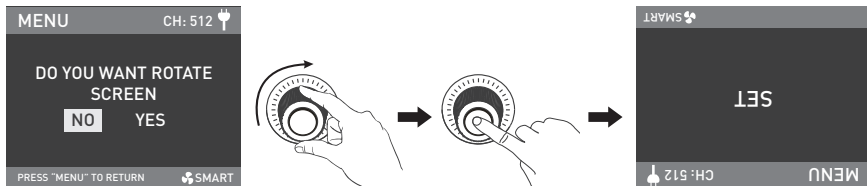

Rotate the right knob to select YES or NO, and press the right knob to set.

3.6 SCREEN BRIGHTNESS

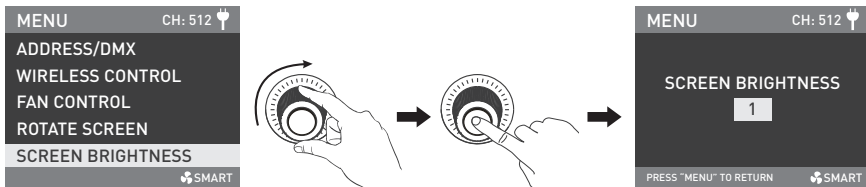

Rotate the right knob to SCREEN BRIGHTNESS, and press the right knob to enter the secondary menu.

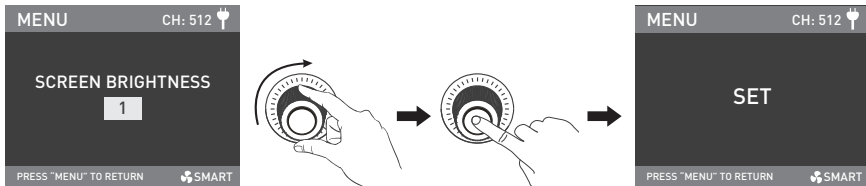

Rotate the right knob to select the screen brightness, and press the right knob to set.

3.7 LANGUAGE

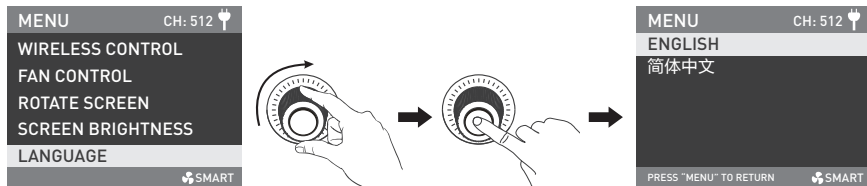

Rotate the right knob to the LANGUAGE, and press the right knob to enter the secondary menu.

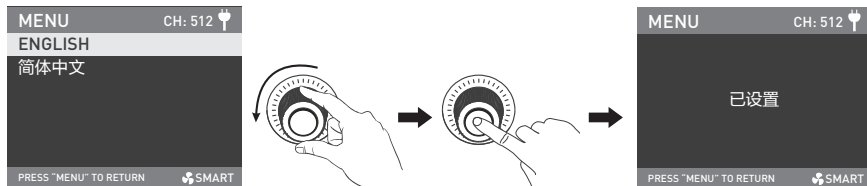

Rotate the right knob to ENGLISH or 简体中文, and press the right knob to set.

3.8 FIRMWARE UPDATE

- Download the firmware file and put into the root directory of the USB drive, and insert the USB drive to the USB port.

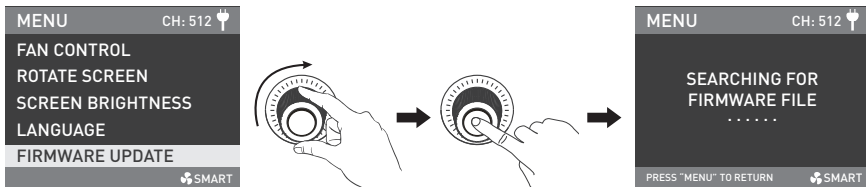

Rotate the right knob to FIRMWARE UPDATE, press the right knob to enter the interface to search for the firmware files.

Note:

- ① Please do not rename the firmware file.
- ② Ensure the USB drive is formatted to FAT, FAT32 or exFAT.
- ③ If prompted that "NO FIRMWARE FOUND", please check whether the firmware file is correct, whether the firmware file is stored in the root directory of the USB drive, or whether the USB drive format is FAT, FAT32 or exFAT.
- ④ If all the above steps are done and the firmware file still cannot be found, please try to format the USB drive again.
- ⑤ If the light fixture still cannot identify the USB drive, please replace the USB drive.

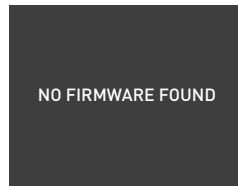
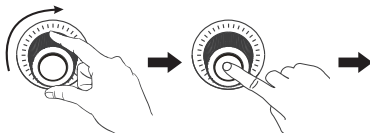
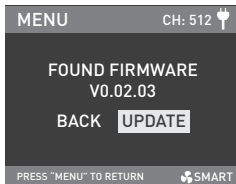

After firmware file is found, enter the firmware update interface, rotate the right knob to select UPDATE, and press the right knob to make update. After update, the light fixture will automatically restart.

3.9.RESET ALL SETTINGS

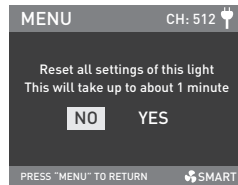
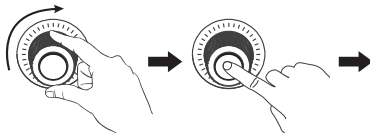
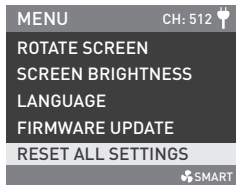

Rotate the right knob to RESET ALL SETTINGS, and press the right knob to enter the secondary menu.

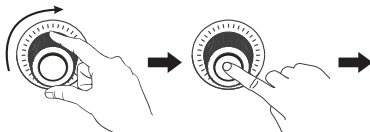
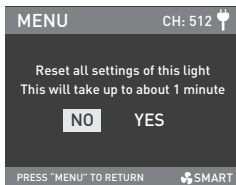

Rotate the right knob to select YES or NO, and press the right knob to set.

3.10 VERSION

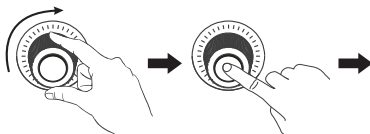
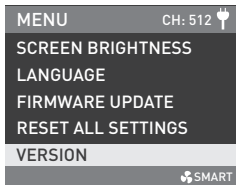

Rotate the right knob to VERSION, and press the right knob to check the current version.

4. When the fixture is not in use, please turn off the power switch.

General Fault Detection and Diagnosis

Fault Detection	Diagnosis
The light won't boot up properly.	<ol style="list-style-type: none"><li data-bbox="495 215 1229 272">1. Please check whether the connection between power supply and cable or fixture are loose.<li data-bbox="495 285 1229 342">2. Please check whether the voltage value of power supply is within the specified range.
The fixture can be operated manually, but DMX control is not working.	<ol style="list-style-type: none"><li data-bbox="495 373 1112 396">1. Please check whether the DMX address setting is correct.<li data-bbox="495 410 1215 467">2. Please check whether the DMX adapter cable is connected correctly and without damaged.
The fan doesn't work.	Please check if the fan is OFF.

Please scan the QR code for more details.



DMX Reference Guide



Detailed User Manual



Nanlite Website



Nanlink App

This manual has been compiled according to the rigorous testing for Nanlite products. Product designs are subject to change without prior notice. The latest version of the manual for this product is downloadable at www.nanlite.com.

Certification

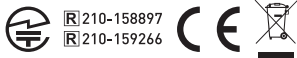
RoHS FC UK
CA

Made in China

WWW.NANLITE.COM

NANLITE

 0754-85751187

 info@nanlite.com

 0754-85300887

 Dongli Section, Highway 324, Chenghai, Shantou City, Guangdong Province, China